

BRIO ULTRA HD PRO BUSINESS WEBCAM

Complete Setup Guide
Guide d'installation complet

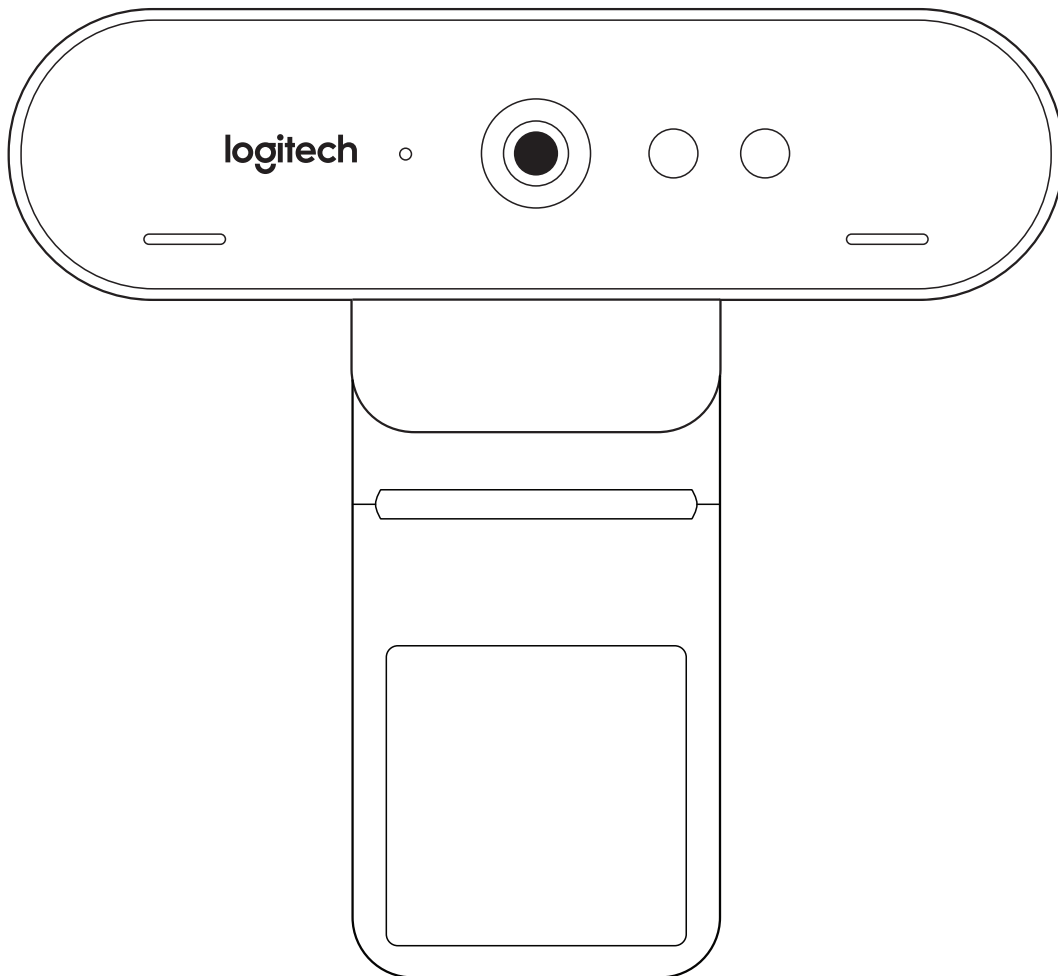

logitech®

CONTENTS

English3

Français9

Español 15

Português 21

KNOW YOUR PRODUCT

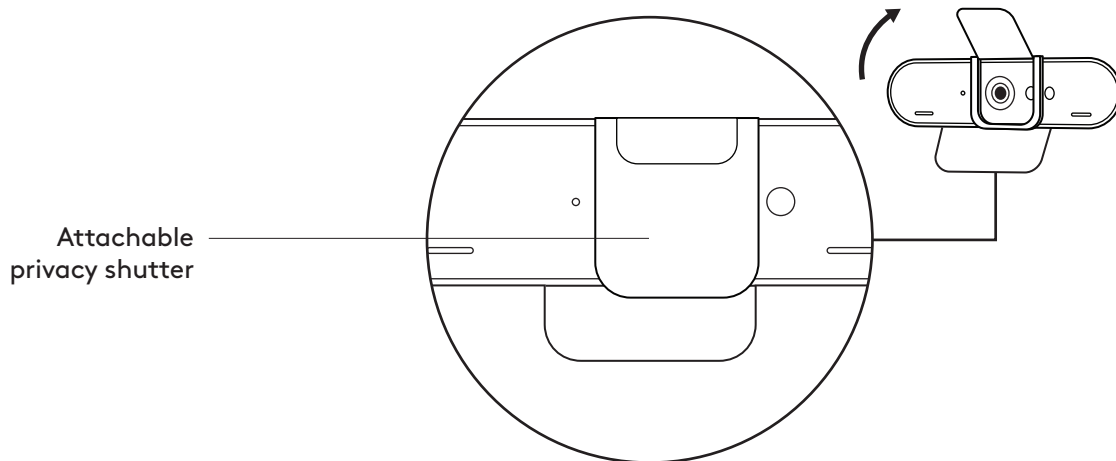
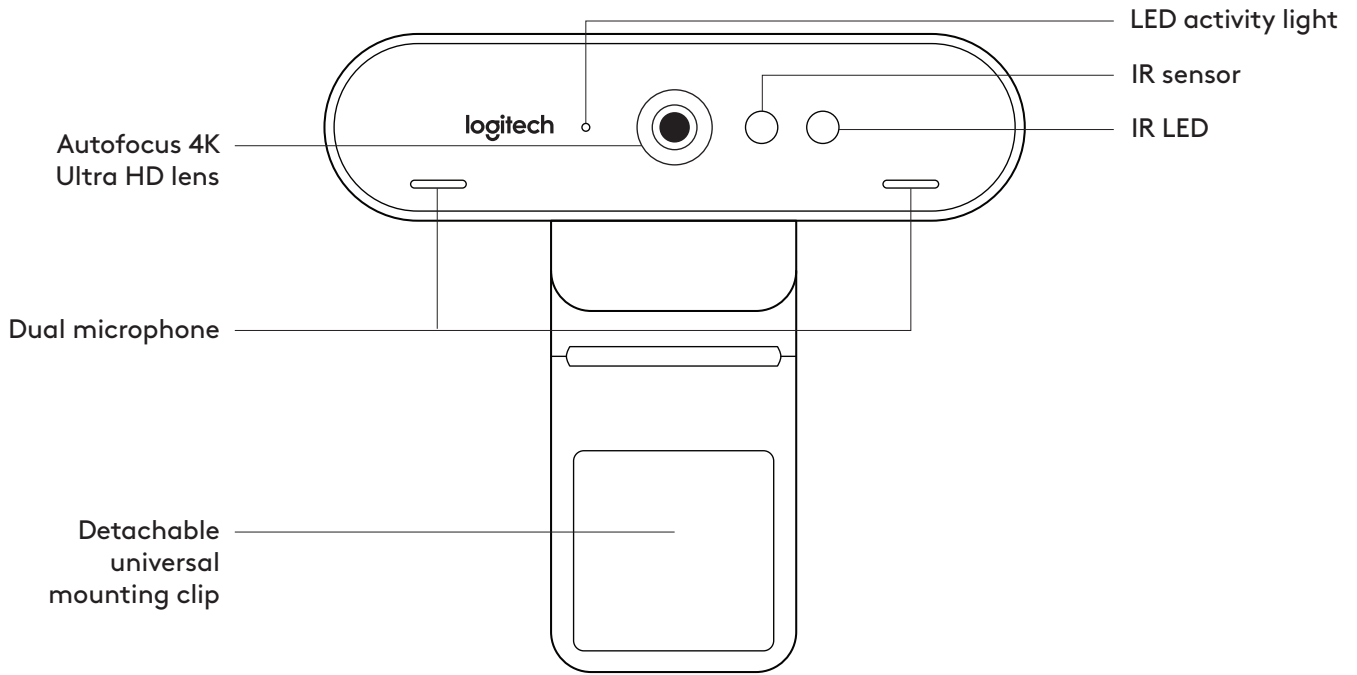

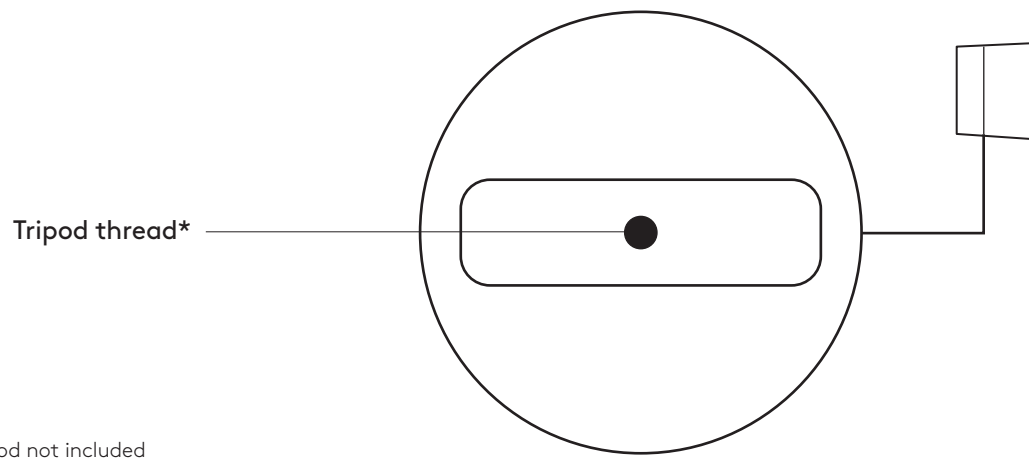

* Tripod not included

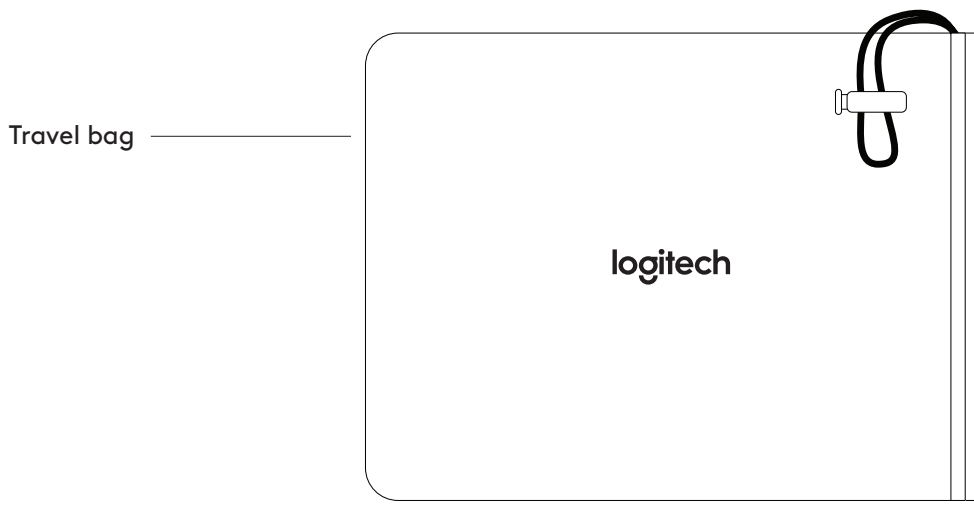
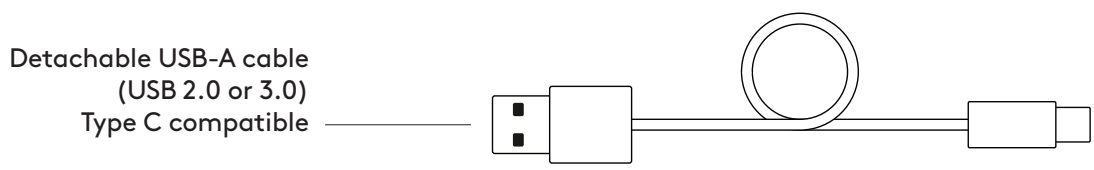

WHAT'S IN THE BOX

- 1 Webcam with detachable universal mounting clip (on webcam)
- 2 External privacy shutter
- 3 Carrying case
- 4 7.2 ft (2.2 m) USB-A to USB-C cable (USB 2.0 or 3.0)
- 5 User documentation

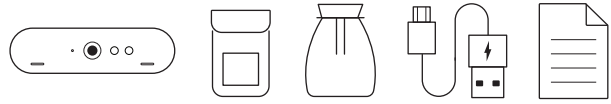

ATTACH THE PRIVACY SHUTTER

- 1 Attach the privacy shutter over the lens on the webcam as shown.

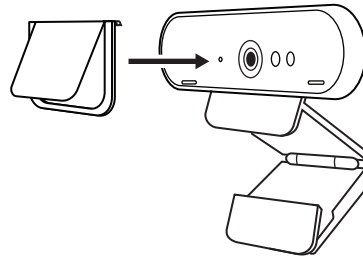

- 2 Snap it onto the front of the webcam, directly over the center.

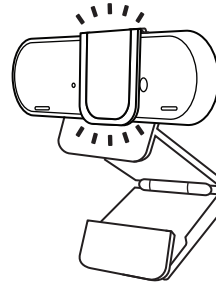

- 3 Manually adjust the privacy shutter to open or close as desired.

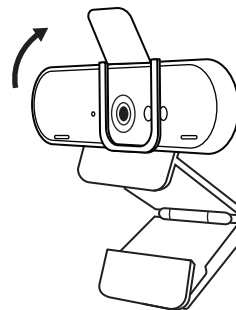

SETTING UP THE WEBCAM

For placement on a monitor

- 1 Place your webcam on a computer, laptop or monitor at a position or angle you desire.

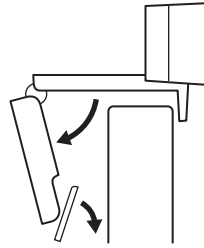

- 2 Adjust the webcam to make sure the foot on the universal mounting clip is flush with the back of your device.

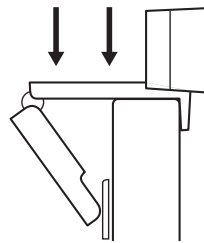

- 3 Manually adjust the webcam up/down to the best position to frame yourself.

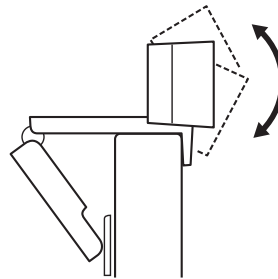

For placement on a tripod*

- 1 Remove the detachable universal mounting clip from the webcam.

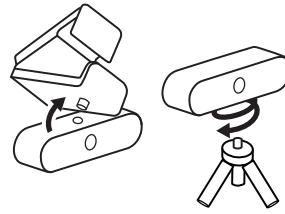

- 2 Locate the 1/4 inch tripod thread on the bottom of the webcam.

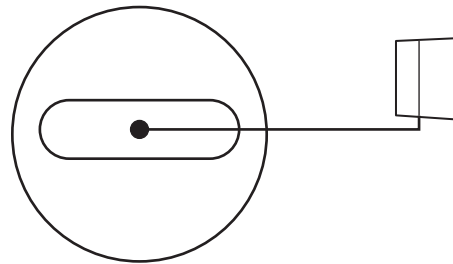

- 3 Secure the webcam on your tripod by twisting it into the 1/4 inch thread.

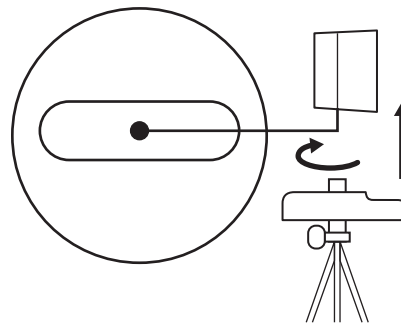

- 4 Place your webcam with the tripod anywhere you desire to the best position to frame yourself.

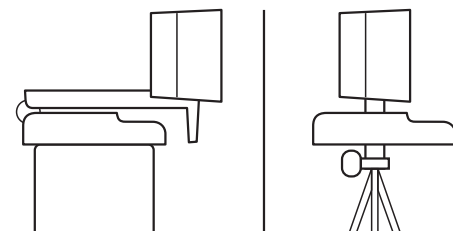

* Tripod not included

CONNECTING THE WEBCAM VIA USB-A

Plug the USB-C end into the webcam and the USB-A connector into the USB-A port on your computer.



SUCCESSFUL CONNECTION

LED activity light will light up when the webcam is in use by an application.

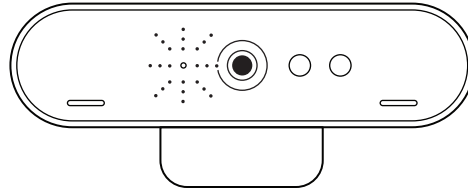

DIMENSIONS

WEBCAM:

Height x Width x Depth:
1.06 in (27 mm) x 4.02 in (102 mm) x 1.04 in (27 mm)

Cable Length: 7.2 ft (2.2 m)

Weight: 2.22 oz (63 g)

ATTACHABLE MOUNTING CLIP:

Height x Width x Depth:
0.75 in (19 mm) x 1.42 in (36 mm) x 2.48 in (63 mm)

Weight: 1.55 oz (44 g)

www.logitech.com/support/brio

PRÉSENTATION DU PRODUIT

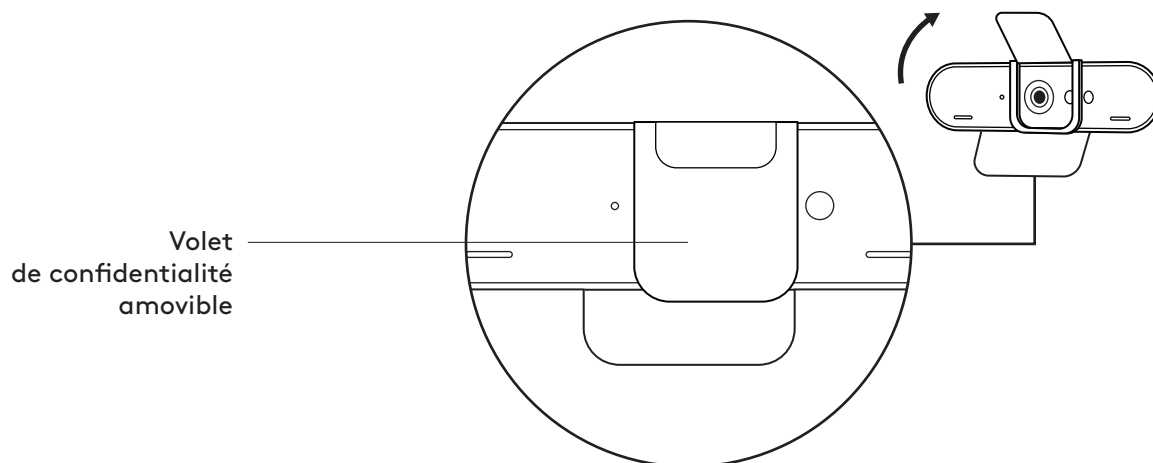
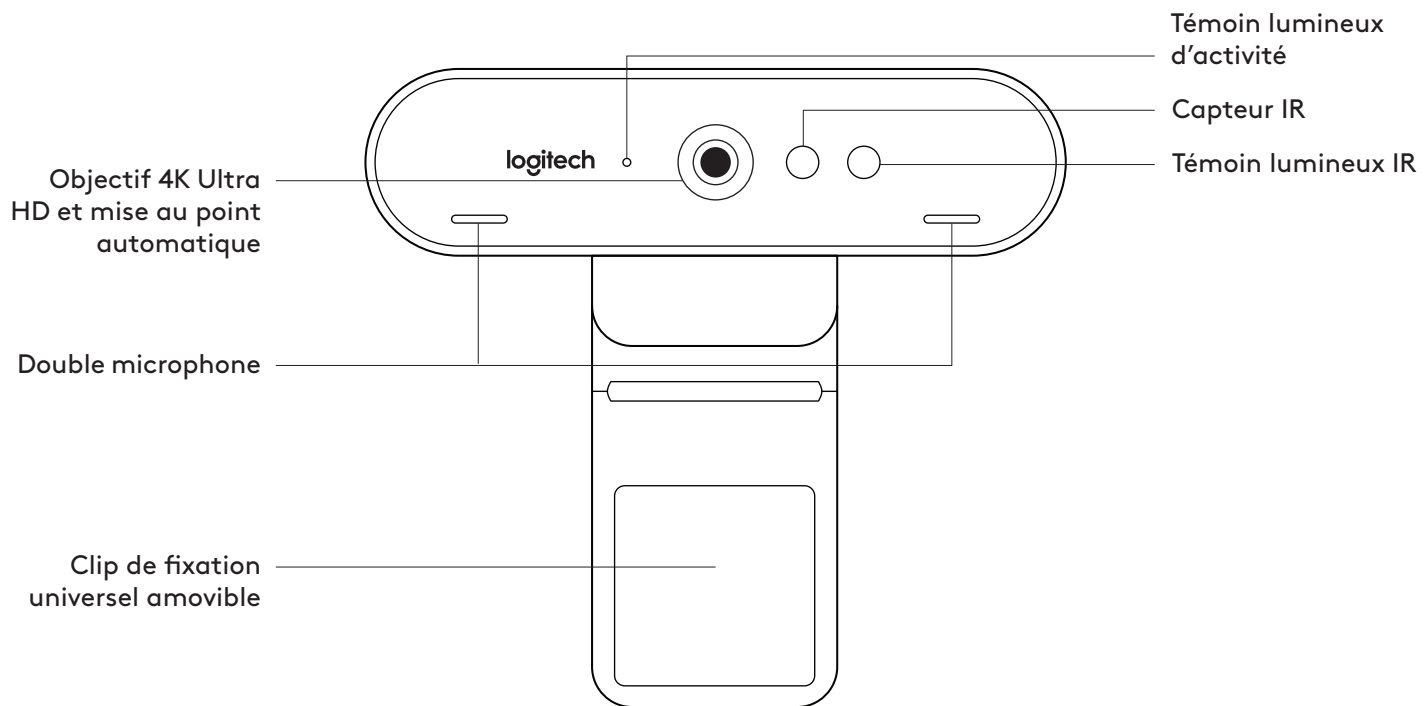

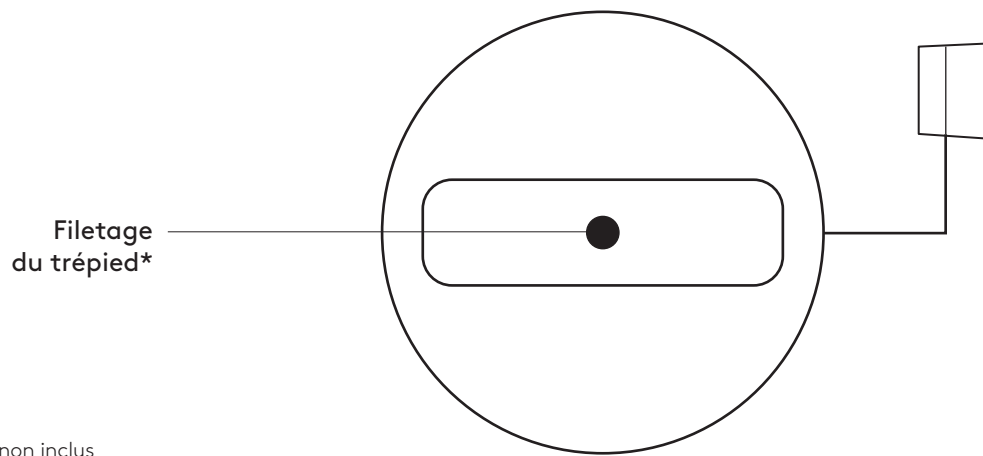

* Trépied non inclus

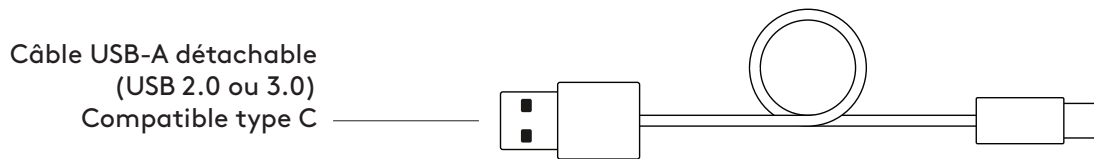

CONTENU

- 1 Webcam avec clip de fixation universel amovible (sur la webcam)
- 2 Volet de confidentialité externe
- 3 Étui de transport
- 4 Câble USB-A vers USB-C de 2,2 m (7,2 pieds)
(USB 2.0 ou 3.0)
- 5 Documentation utilisateur

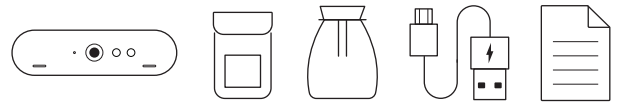

FIXATION DU VOLET DE CONFIDENTIALITÉ

- 1 Rattachez le volet de confidentialité au-dessus de l'objectif sur la webcam, comme illustré.

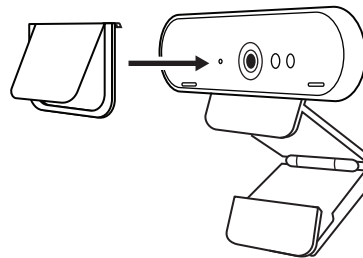

- 2 Fixez-le à l'avant de la webcam, directement sur le centre.

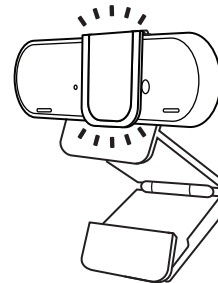

- 3 Ajustez manuellement le volet de confidentialité pour l'ouvrir et le fermer à votre convenance.

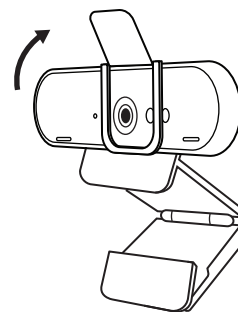

INSTALLATION DE LA WEBCAM

Fixation sur un écran

- 1 Placez votre webcam sur un ordinateur, un ordinateur portable ou un écran à l'angle ou dans la position de votre choix.



- 2 Ajustez la webcam pour vous assurer que le pied du clip de fixation universel est aligné avec l'arrière de votre dispositif.

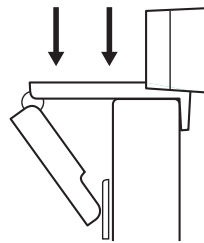

- 3 Ajustez manuellement la webcam vers le haut/bas pour vous cadrer au mieux.

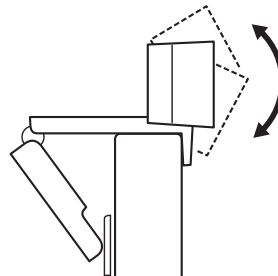

Fixation sur un trépied*

- 1 Retirez le clip de fixation universel amovible de la webcam.

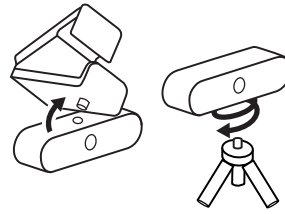

- 2 Recherchez le filetage du trépied de ¼ pouce sous la webcam.

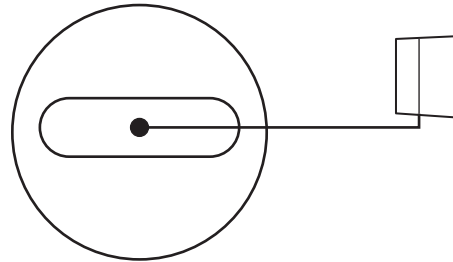

- 3 Sécurisez la webcam sur le trépied en la vissant sur le filetage ¼ pouce.

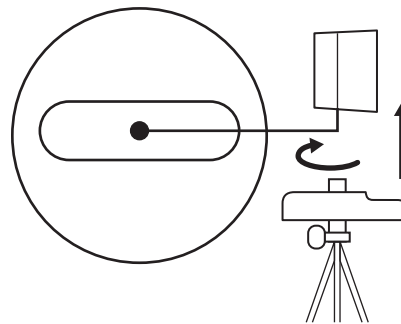

- 4 Placez votre webcam sur le trépied selon votre convenance dans la meilleure position pour vous cadrer.

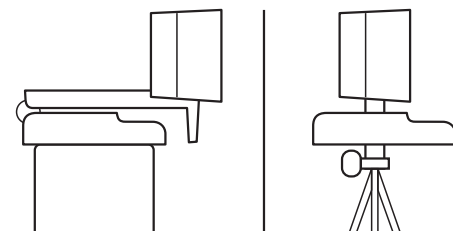

* Trépied non inclus

CONNEXION DE LA WEBCAM VIA USB-A

Branchez l'extrémité du câble USB-C à la webcam, et le connecteur USB-A sur le port USB-A de votre ordinateur.



CONNEXION RÉUSSIE

Le témoin lumineux d'activité s'allumera lorsque la webcam est utilisée par une application.

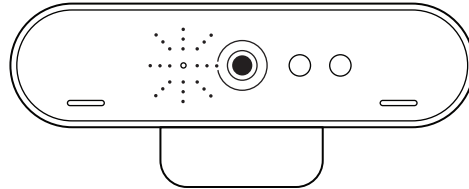

DIMENSIONS

WEBCAM:

Hauteur x largeur x profondeur:
27 mm (1,06 pouce) x 102 mm (4,02 pouces) x 27 mm (1,04 pouce)

Longueur du câble: 2,2 m (7,2 pieds)

Poids: 63 g (2,22 onces)

CLIP DE FIXATION AMOVIBLE

Hauteur x largeur x profondeur:
19 mm (0,75 pouce) x 36 mm (1,42 pouce) x 63 mm (2,48 pouces)

Poids: 44 g (1,55 once)

www.logitech.com/support/brio

COMPONENTES DEL PRODUCTO

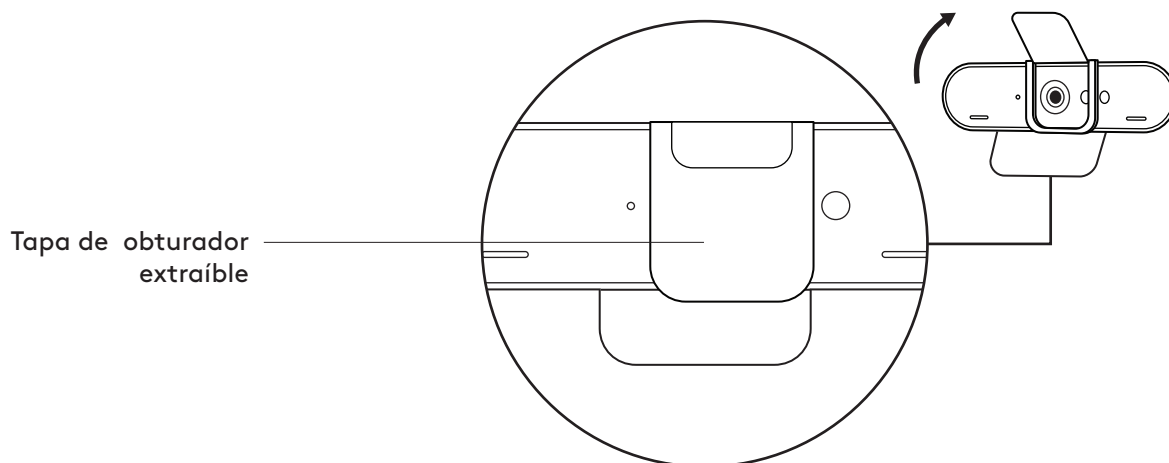
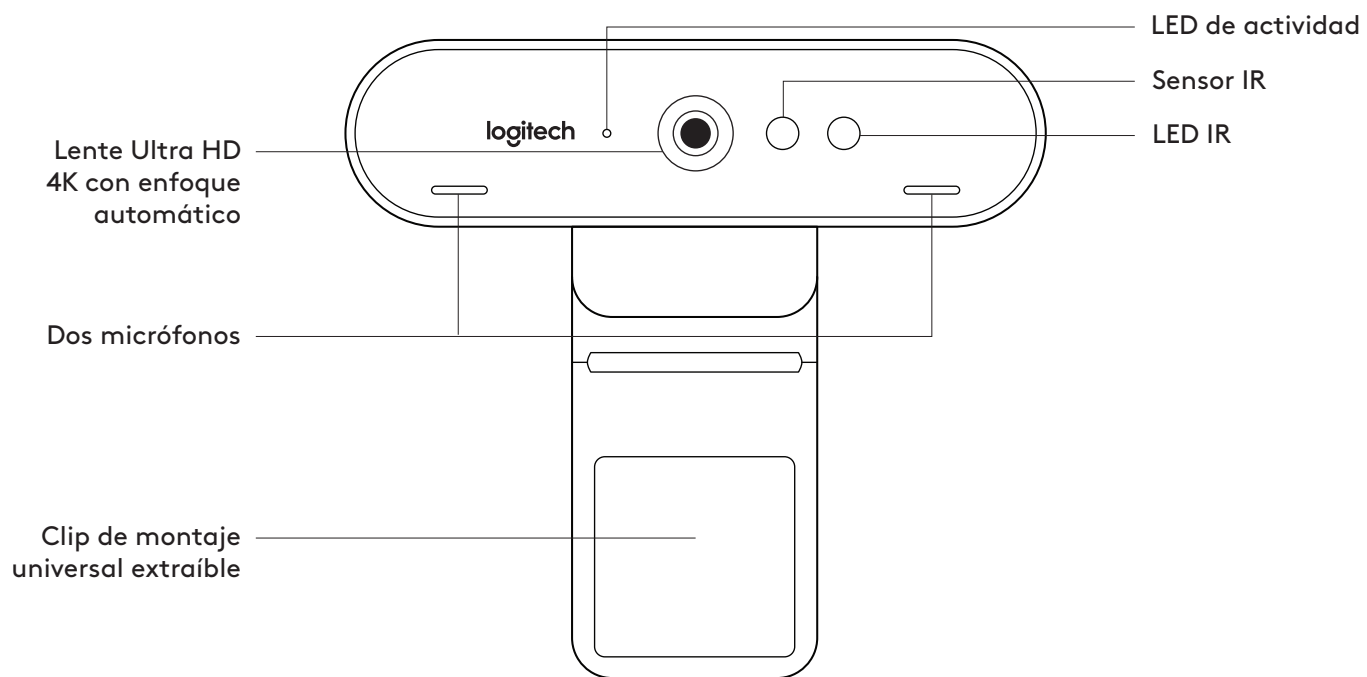

Adaptador
para trípode*

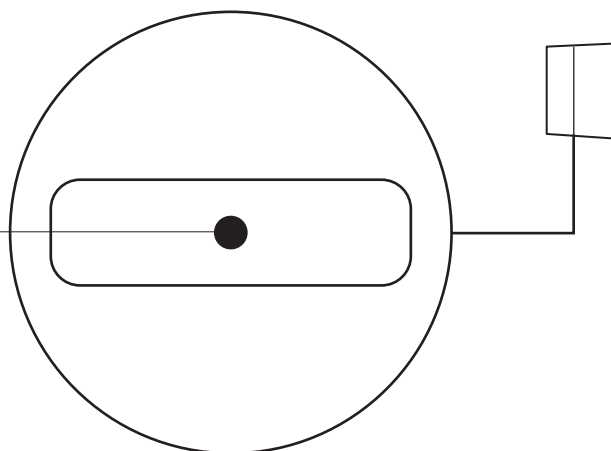

* Trípode no incluido

Cable USB-A extraíble
(USB 2.0 o 3.0)
Compatible con tipo C

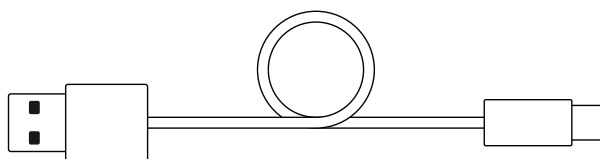

Bolsa de viaje

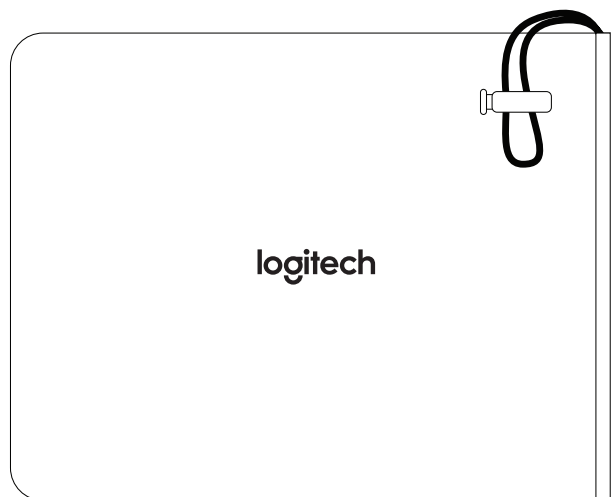

CONTENIDO DE LA CAJA

- 1 Cámara Web con clip de montaje universal extraíble
- 2 Tapa de obturador externa
- 3 Funda protectora
- 4 Cable USB-A a USB-C de 2,2 m (7,2 ft) (USB 2.0 o 3.0)
- 5 Documentación del usuario

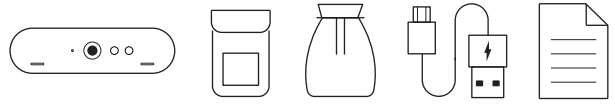

COLOCA LA TAPA DEL OBTURADOR

- 1 Coloca la tapa de obturador sobre la lente de la cámara Web como se muestra.

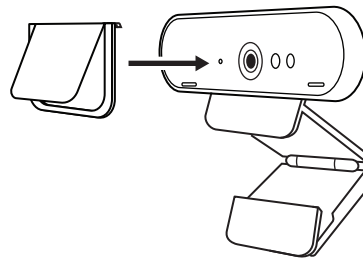

- 2 Encájala en la parte frontal de la cámara Web, directamente sobre el centro.

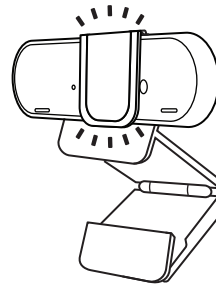

- 3 Ajusta manualmente la tapa de obturador para abrir o cerrar según prefieras.

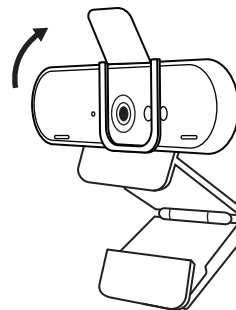

INSTALACIÓN DE LA CÁMARA WEB

Para la colocación en un monitor

- 1 Coloca la cámara sobre una computadora, una laptop o un monitor, en la posición o el ángulo que desees.

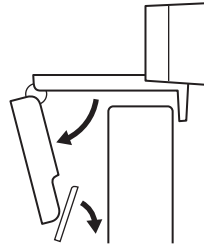

- 2 Ajusta la cámara de modo que la pata del clip de montaje universal quede al ras de la parte posterior del dispositivo.

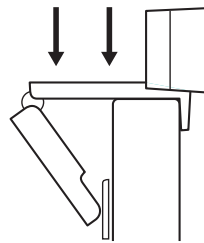

- 3 Inclina manualmente la cámara Web hacia arriba/abajo para enmarcarte en la imagen del mejor modo posible.

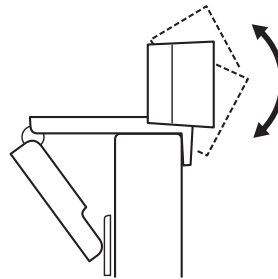

Para la colocación en un monitor*

- 1 Retira el clip de montaje universal extraíble de la cámara Web.

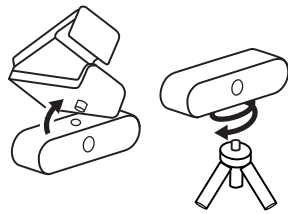

- 2 Localiza el adaptador para trípode de ¼" en la parte inferior de la cámara.

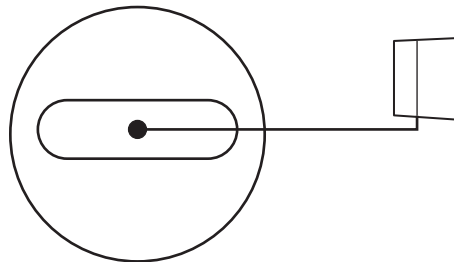

- 3 Fija la cámara Web al trípode, girándolo en el adaptador de ¼ de pulgada.

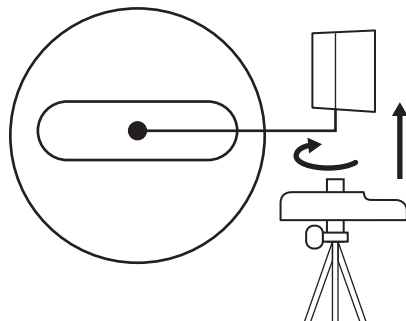

- 4 Coloca la cámara Web con el trípode en el sitio que quieras para lograr la mejor posición para enmarcarte perfectamente.

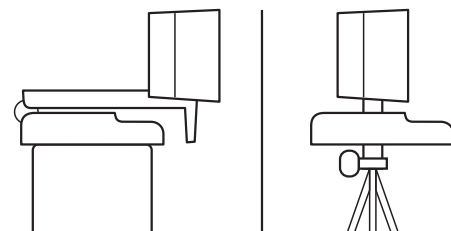

* Trípode no incluido

CONEXIÓN DE LA CÁMARA WEB POR USB-A

Conecta el extremo USB-C a la cámara Web y el conector USB-A al puerto USB-A de la computadora.



CONEXIÓN REALIZADA CORRECTAMENTE

El diodo LED de actividad se iluminará cuando la cámara se esté usando en una aplicación.

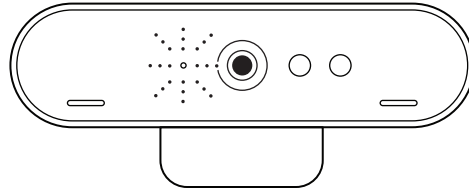

DIMENSIONES

CÁMARA WEB:

Altura x Anchura x Profundidad:
27 mm (1,06 in) x 102 mm (4,02 in) x 27 mm (1,04 in)

Longitud del cable: 2,2 m (7,2 ft)

Peso: 63 g (2,22 oz)

CLIP DE MONTAJE ACOPLABLE:

Altura x Anchura x Profundidad:
19 mm (0,75 in) x 36 mm (1,42 in) x 63 mm (2,48 in)

Peso: 44 g (1,55 oz)

www.logitech.com/support/brio

CONHECER O PRODUTO

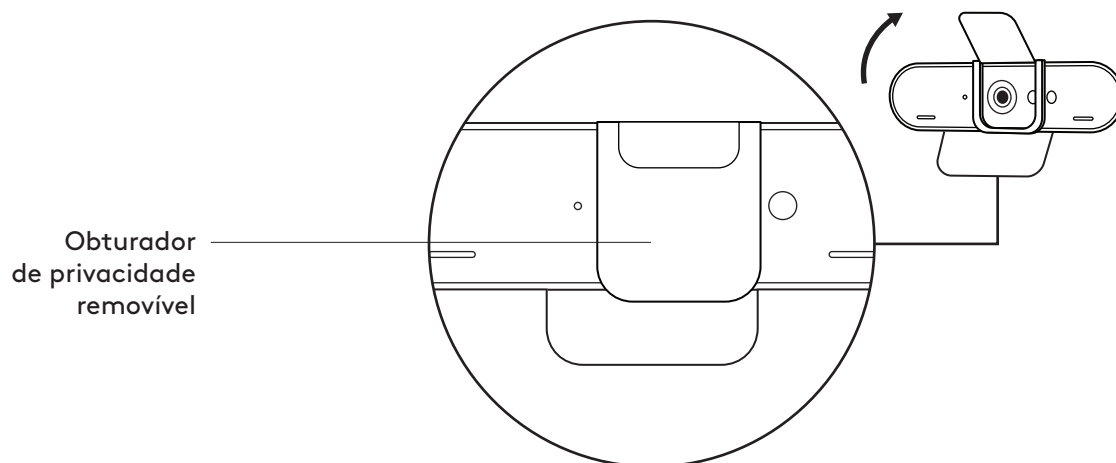
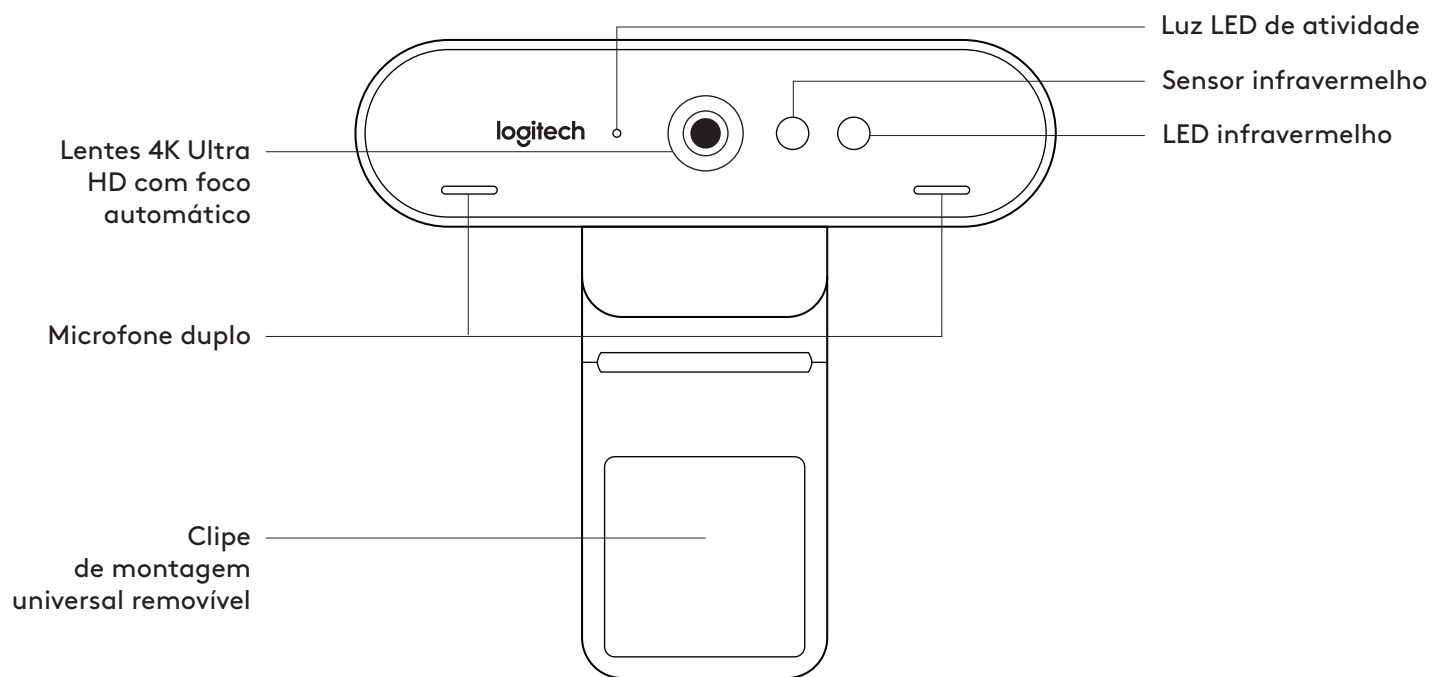

Rosca do tripé*

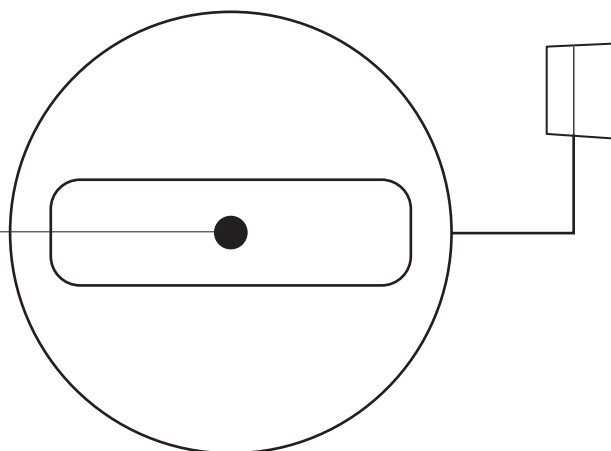

* Tripé não incluído

Cabo USB-A removível
(USB 2.0 ou 3.0)
Compatível com tipo C

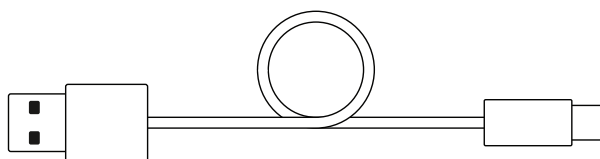

Bolsa
para transporte

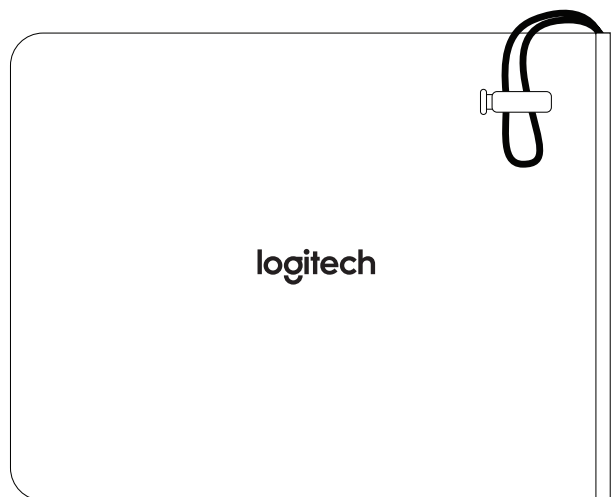

O QUE A CAIXA CONTÉM

- 1 Webcam com clipe de montagem universal removível (na webcam)
- 2 Obturador de privacidade externo
- 3 Estojo para transporte
- 4 Cabo USB-A a USB-C (USB 2.0 ou 3.0) de 2,2 m (7,2 pés)
- 5 Documentação do usuário

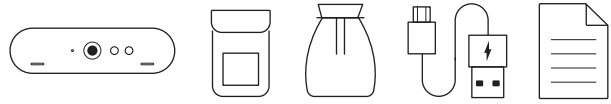

ANEXE A PROTEÇÃO DE PRIVACIDADE

- 1 Fixe o obturador de privacidade sobre a lente da webcam, conforme mostrado.

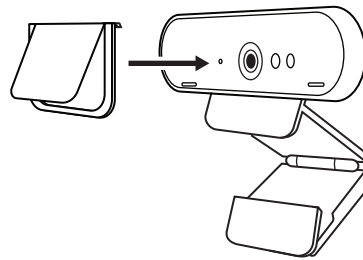

- 2 Encaixe-o na frente da webcam, diretamente no centro.

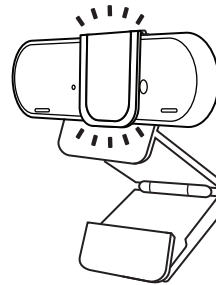

- 3 Ajuste manualmente a proteção de privacidade para abrir ou fechar conforme desejado.

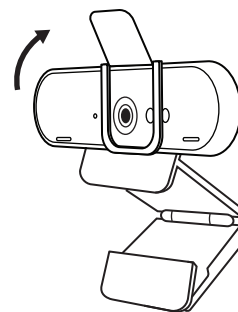

INSTALAÇÃO DA WEBCAM

Para posicionamento em um monitor

- 1 Posicione a webcam no computador, laptop ou monitor na posição ou ângulo desejado.



- 2 Ajuste a webcam para garantir que o pé do clipe de montagem universal esteja alinhado com a parte de trás do dispositivo.

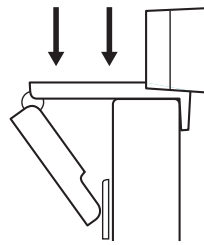

- 3 Ajuste manualmente a webcam para cima/baixo à melhor posição para se enquadrar.

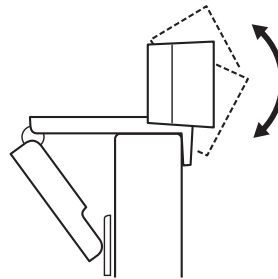

Para posicionamento em um tripé*

- 1 Remova o clipe de montagem universal removível da webcam.

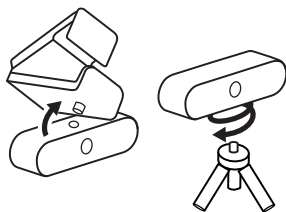

- 2 Localize a rosca do tripé de 1/4 de polegada na parte inferior da webcam.

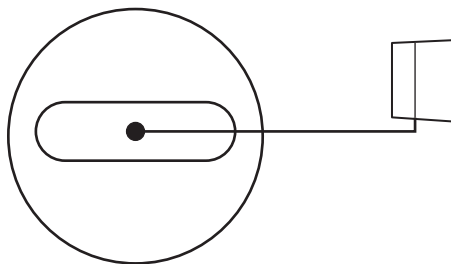

- 3 Prenda a webcam no seu tripé girando o tripé na rosca de 1/4 de polegada.

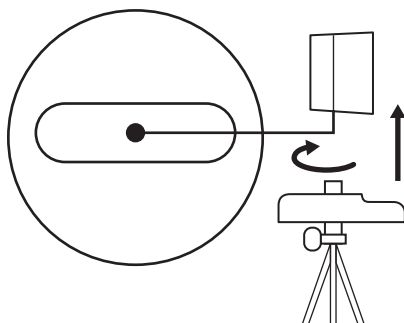

- 4 Coloque sua webcam com o tripé em qualquer lugar que desejar, na melhor posição para se enquadrar.

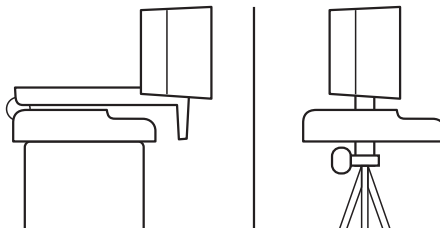

* Tripé não incluído

CONECTANDO A WEBCAM VIA USB-A

Conecte a extremidade do USB-C na webcam e o conector USB-A na porta USB-A do seu computador.



CONEXÃO BEM-SUCEDIDA

A luz LED de atividade acenderá quando a webcam estiver sendo usada por um aplicativo.

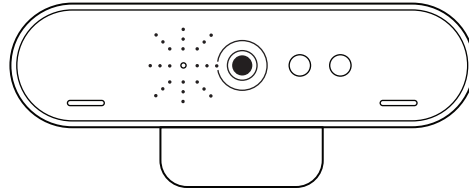

DIMENSÕES

WEBCAM:

Altura x largura x profundidade:
27 mm (1,06 pol.) x 102 mm (4,02 pol.) x 27 mm (1,04 pol.)

Comprimento do cabo: 2,2 m (7,2 pés)

Peso: 63 g (2,22 oz)

CLIQUE DE MONTAGEM REMOVÍVEL:

Altura x largura x profundidade:
19 mm (0,75 pol.) x 36 mm (1,42 pol.) x 63 mm (2,48 pol.)

Peso: 44 g (1,55 oz)

www.logitech.com/support/brio