

# Quick Setup Guide

SERIES **3**  
**350**

Congratulations on the purchase of your new Samsung TV. Read this setup guide to get your TV up and running quickly.

**STOP**

Please do not return this unit. If you have problems operating your TV call: 1-800-SAMSUNG (1-800-726-7864). For web support please visit: [www.samsung.com/support](http://www.samsung.com/support)

1-800-SAMSUNG (1-800-726-7864)  
Samsung Electronics America, Inc.  
85 Challenger Road Ridgefield Park, NJ 07660-2112  
Samsung Electronics Canada Inc.  
55 Standish Court Mississauga, Ontario L5R 4B2  
Call Center hours of operation: Mon-Sun, 9:00 AM - 12 AM EST.  
To register this product, visit : [www.samsung.com/register](http://www.samsung.com/register).

## Getting Started

### Step 1 : Install the Stand

Follow the steps below to connect the TV to the stand.

- Make sure to distinguish between the front and back of the Stand and Guide Stand when assembling them.
- Make sure that at least two people lift and move the LCD TV.
- Lay the product down, with the screen facing up and fasten the screws.

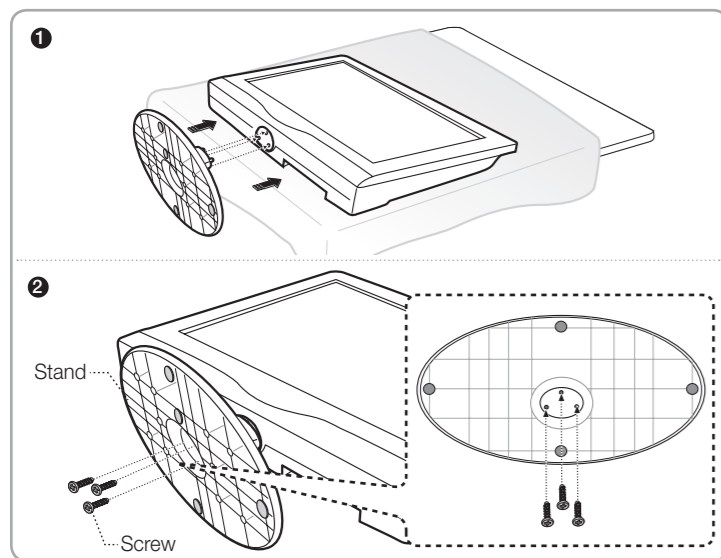

### Step 2 : Install the Batteries into the Remote

To install batteries into your remote control, follow these steps:

- Lift the cover on the back of the remote upward as shown in the figure to the right.
- Install two AAA batteries.
  - Make sure to match the + and - ends of the batteries to the diagram in the battery compartment.
- Replace the cover.

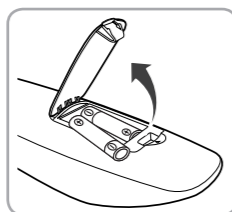

### Step 3 : Connect Power and Antenna or Cable

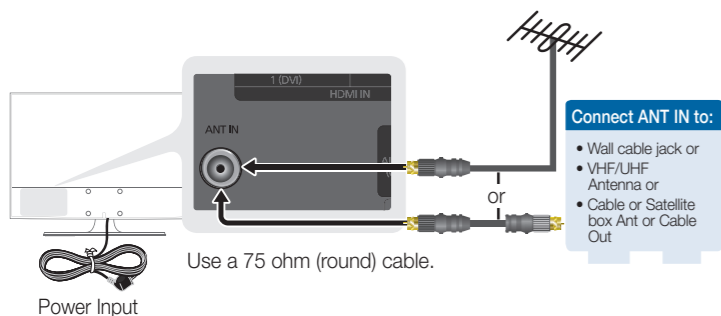

## Step 4 : Connect External Devices

### Connecting an AV device (Blu-ray player, cable/satellite box, etc.)

For the very best picture quality, select HD signal sources and use HDMI cables and connections. Note that many digital cable programs are not in HD. Check with your video provider to ensure you are receiving HD signals.

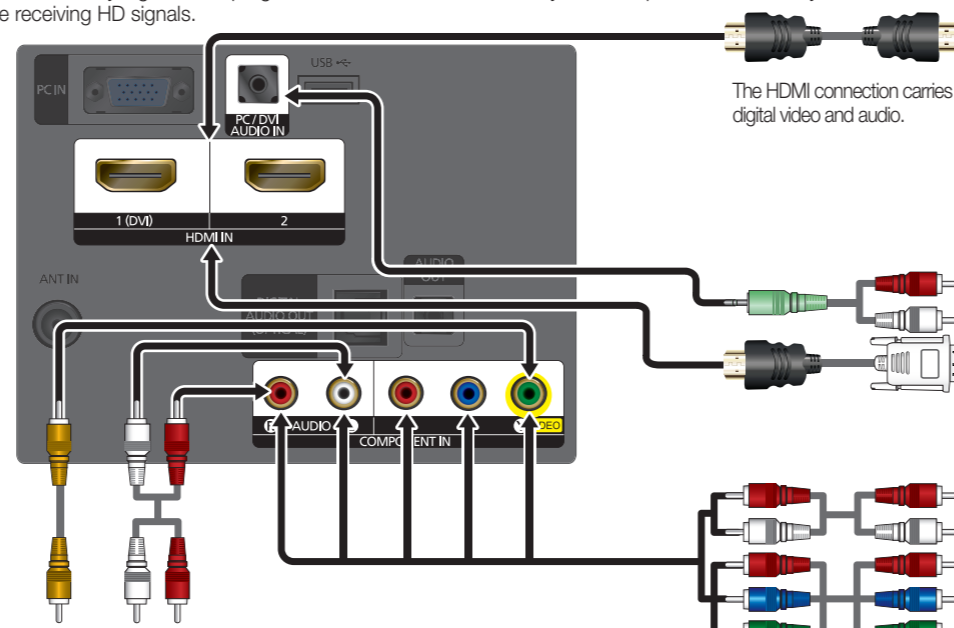

The HDMI connection carries digital video and audio.

#### ★ HD connection (up to 1080p)

**Using an HDMI Cable**

HDMI OUT Device

DVD / Blu-Ray player / HD Cable Box / HD Satellite receiver (STB)

Best Connection

#### ★ HD connection (up to 1080p)

**Using an DVI to HDMI Cable**

AUDIO OUT Device

DVI OUT DVD / Blu-Ray player / Cable Box / Satellite receiver (STB)

Very Good Connection

#### Component connection (up to 1080p)

**Using a Component Cable**

AUDIO OUT COMPONENT OUT Device

VCR / DVD / Blu-ray player / Cable Box / Satellite receiver

Good Connection

#### Audio/Video connection (480i only)

**Using an Audio/Video Cable**

VIDEO OUT AUDIO OUT VCR

VCR / DVD / Blu-ray player / Cable Box / Satellite receiver

Lowest Quality Connection

### Step 5 : Run Plug & Play

When you turn on your TV for the first time, it automatically launches the **Plug & Play** function. With **Plug & Play**, you can select the On Screen Display language, set the clock mode, and launch the TV's channel memorizing process. It also displays connection instructions similar to those in this guide.

To navigate while **Plug & Play** is running, press the Up, Down, Left or Right arrow buttons on your remote. To make a selection, press the ENTER button. To skip a screen, press the MENU button.

To turn on your TV, press the POWER button on the remote or press the POWER button on the TV. To run **Plug & Play**, follow these steps:

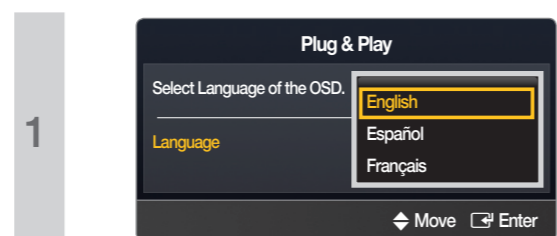

On the Language screen, select the language for the On Screen Display (OSD) using your remote control, and then press ENTER button. The Home Use screen appears.

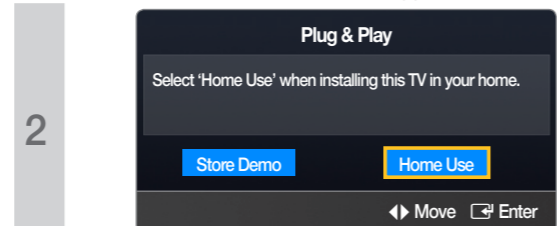

Select **Home Use**, and then press ENTER button. If you select **Store Demo**, the TV will reset your picture and audio settings every 30 minutes. After you press ENTER button, the Antenna Source screen appears.

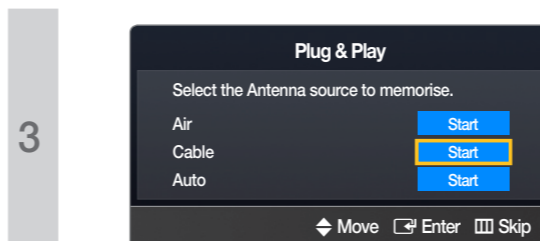

If your TV is only attached to an antenna, select **Air**. If your TV is only attached to cable and you have no cable box, select **Cable**. If your TV is attached to an antenna and cable with no box, select **Auto**. When done, press ENTER button on your remote. The **Select Cable System** screen appears.

**IMPORTANT:** If your TV is attached to a cable or satellite box, skip Steps 3 through 5. After **Plug & Play** is complete, set your TV to Channel 3 or 4, according to the directions for your cable or satellite box.

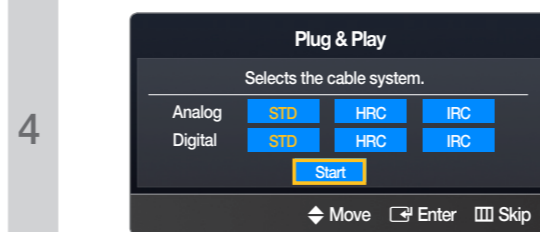

If your TV is attached to a cable system and you have no cable box, you must select your cable system type. If you have Digital cable, you must select the cable system type for both **Analog** and **Digital**.

After you have selected the cable system type, select **Start**, and then press the ENTER button on your remote.

Most cable systems are Standard (STD) systems. If you are not sure about what kind of cable system you have, contact your cable company.

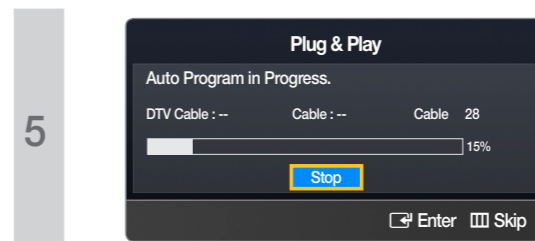

The TV memorizes the available channels. This process can take up to 45 minutes.

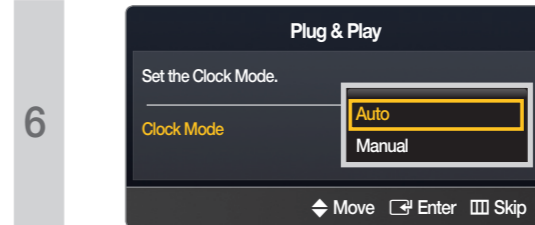

After the TV has memorized the channels, choose the **Clock Mode**. Select **Auto** if you have a digital channel in your area. Select **Manual** if you don't, or if you have a cable or satellite box. When done, press ENTER button.

If you select **Manual**, the clock setting screen appears.

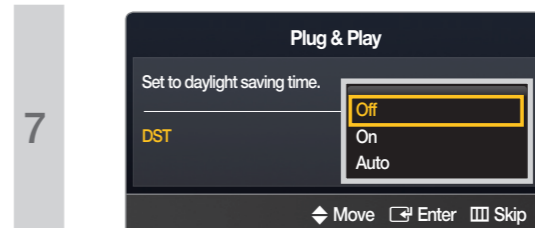

Select the daylight savings time setting: **Off**, **On**, or **Auto**, and then press ENTER button.

### Connecting an audio device

Connect your TV to your Home Theater or other audio device to enjoy enhanced sound quality.

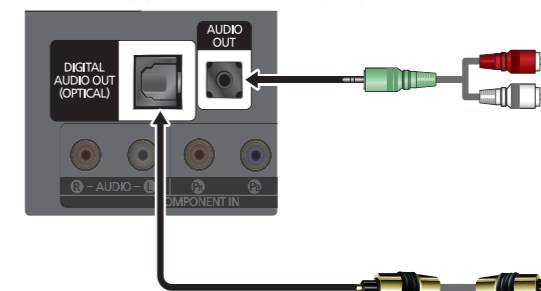

#### Analog Audio connection

**Using an Audio Cable**

AUDIO IN Device

Amplifier / DVD Home Theater

#### ★ Digital Audio connection

**Using an Optical Cable**

OPTICAL Digital Audio System

### Connecting a PC

Connect your TV to a PC to use it as a Monitor.

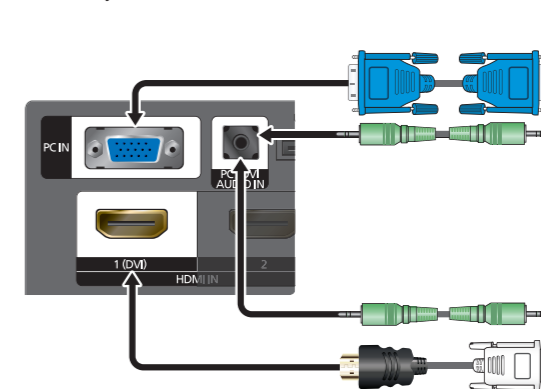

#### ★ HD connection

**Using a D-Sub Cable**

PC OUT AUDIO OUT PC

**Using an HDMI Cable**

AUDIO OUT DVI OUT PC

# Basic Functions

## Changing the Screen Size

Your TV has several screen size options, each designed to work best with specific types of video input. If you have a cable box or satellite receiver, it may have its own set of screen sizes as well.

To change the screen size, press the P.SIZE button on your remote. The first time you press it, your TV displays the current setting. Thereafter, each time you press the P.SIZE button, you change the size of the picture on the screen.

The following sizes are available:



**Screen Fit** displays a full HD picture covering the entire screen with no cutoff on any side. It is only available when your TV inputs an HDMI (720p, 1080i, 1080p), Component (1080i, 1080p), or DTV (over-the-air 1080i) signal.

## Changing the Picture Mode

Your TV has three preset Picture Modes with factory adjusted settings, each designed to give you an excellent picture under specific conditions.

The Picture Modes are listed and described in the table below:

Mode	Description
<b>Dynamic</b>	Brightens picture. For a vibrant, enhanced image in brightly lit or sunny room.
<b>Standard</b>	For a bright, detailed picture in a normally lit room.
<b>Movie</b>	For a studio quality cinema picture in a dimly lit or dark room.

To change the Picture Mode, follow these steps:

- With the TV on, press the TOOLS button on your remote. The Tools menu appears.
- Using the ▲ or ▼ on your remote, select **Picture mode**.
- On the **Picture Mode** menu, use the ◀ or ▶ on your remote to select the **Picture Mode** you want.
- Press the EXIT button to exit the menu.

## Viewing the On Screen Menus

To view the On Screen Menus, follow these steps:

- With the power on, press the MENU button on your remote. The main menu appears. The menu's left side has the following menu options: **Picture, Sound, Channel, Setup, Input, Application, and Support**.
- Press the ▲ or ▼ button on your remote to select a menu option, and then press the ENTER button.
- When done using the menu, press the EXIT button on your remote to exit.

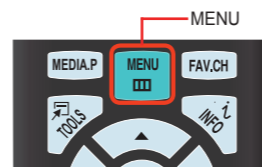

## Selecting a Source

To watch a movie on your Blu-ray player or watch your favorite TV show, you must select the correct source. A source is a device, such as a Blu-ray/DVD player, a cable/satellite box, antenna or a cable TV input. Sources can be connected to your TV through the HDMI, DVI, Component, Composite, or D-sub connections, or through the Antenna or Cable In connections.



To view the signal from a source connected to the HDMI, DVI, Component, Composite, or D-sub jack, press the SOURCE button on your remote. Each time you press the SOURCE button, you change to a different source.

## Changing Channels and Adjusting the Volume



Adjust the volume by pressing the -VOL+ button on the remote.

Change the channels by pressing the ▼CH▲ button on the remote.

If your TV is attached to a cable or satellite box, change the channel using the box's remote.

You can also change the channels by pressing the ▼CH▲ buttons on the front panel of your TV and adjust the volume by pressing the -VOL+ buttons.

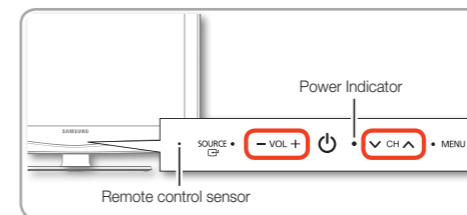

## Connecting a USB Device for Media Play

You can enjoy photo, music, and movie files stored on a USB device by connecting it to the TV and using the Media Play feature. To connect a USB device for Media Play, follow these steps:

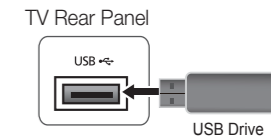

- Turn on your TV.
- Connect a USB device containing photo, music and/or movie files to the USB jack on the rear of the TV.
- When the Application selection screen appears, press the ENTER button on your remote to select **Media Play (USB)**.

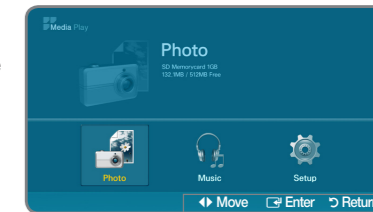

## Remote Control Buttons and Functions:

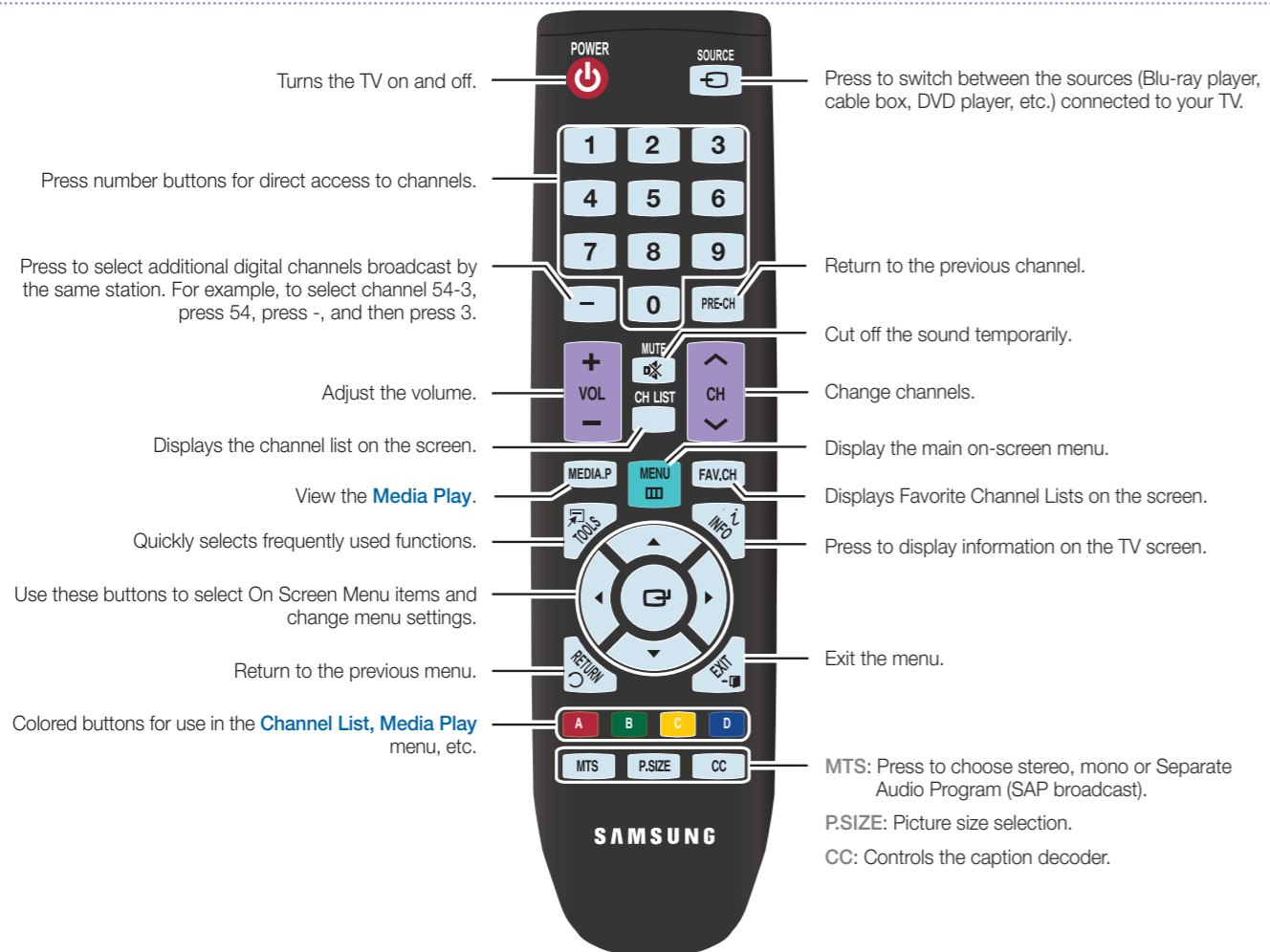

## Setting the Clock

Before you can use your TV's On/Off Timer, you must set the clock. To set the clock, follow these steps:

- Turn on your TV.
- Using your remote, press the MENU button on your remote. Then, select **Setup** → **Time**.
- Select **Clock Mode**, and then press the ENTER button. Set **Clock Mode** to **Auto** or **Manual**.  
Select Auto if you have a digital channel in your area and are not using a cable/sat box.
- Select **Clock Set**, and then press the ENTER button. The Clock Set screen appears.
- Using the number buttons on your remote, enter the **month, day, year, hour, and minute**. Use the ◀ or ▶ button to move between entry fields.
- Press the RETURN button on your remote when done.

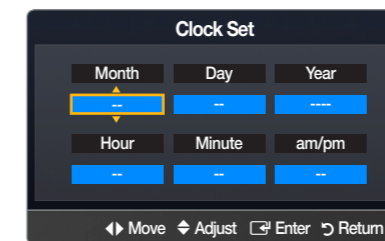

BN68-02621A-04